

## Statistical Modeling in Fire-ignition Hazard Evaluation

J. Šrekl\* and J. Golob

Faculty for Chemistry and Chemical Technology,  
Aškerčeva 5, 1000 Ljubljana, Slovenia

Original scientific paper

Received: July 2, 2008

Accepted: February 24, 2009

The probabilistic approach to the evaluation of fire hazard and the effectiveness of fire-precaution measures enables a rational response to the randomness of fire outbreaks. This article employs the statistical analysis methods to elucidate the causes for the ignition of fire on a random sample of industrial buildings in the Republic of Slovenia. The analyses are based on the Structural Equation Modeling (SEM), which is a well-established and important statistical analysis technique in the fields of biology, psychology and medicine, but hitherto rarely applied in safety research. The results of the study demonstrate that for the analyzed random sample of industrial buildings the frequency of fire outbreaks statistically significantly depends only on the presence and the probability of exposition to the heat sources (flames, sparks, and hot surfaces), but does not significantly depend on the available quantity of flammable materials within the industrial structure.

*Key words:*

Fire, ignition, fire hazard evaluation, structural equation modeling

### Introduction

Over 2000 fires of various extents break out annually in the Republic of Slovenia (RS).<sup>1,2</sup> Many of these fires are not predictable, especially those that break out in the private residential areas (apartments, houses, dumpsters, etc.). The fire outbreaks in the industrial structures and areas often occur due to some inappropriate action(s) by the workers employed there.

Therefore, it is important to ask whether there exist some predictable causes for the ignition of industrial fires. Based on the reports on some 75,000 work-related accidents, Seo<sup>3</sup> established that 88 % of accidents were caused by the inappropriate actions of workers. However, when discussing the “human factor”, one is well advised to exercise caution. Petersen<sup>4</sup> concluded that the key causes for the majority of work-related accidents are linked to actions of the management, control, or to their qualifications. This conclusion is echoed by Heinrich *et al.*,<sup>5</sup> who suggested three fundamental causes of accidents. “While we often think of hazardous acts and conditions as the basic causes of accidents, they are actually only symptoms of failure. The basic causes are usually traceable to poor management policies and decisions, and personal and environmental factors”. In the USA work-related accidents, the “human factor” exerts the most important influence (in order of their importance) on the conditions of preventive rescue, conditions before injury, activities during the accident, location of the fire

outbreak, and causes of injury.<sup>6</sup> Like many other natural processes the fire sequence can be understood as a stochastic process, in which every event is mainly characterized by its spatial location, time of occurrence, and size of the fire affected area.<sup>7</sup>

There are two fundamentally different approaches to the fire hazard analysis: the deterministic and the probabilistic. The deterministic approach considers the fire outbreaks to be connected directly to the preceding mistakes. The general methodology of the probabilistic approach to the fire hazard analysis, on the other hand, enables connecting the various aspects of fire safety precautions and the ignition of fire. The probability approach offers rational methods of dealing with the inherently random nature of fire hazard and ensuring effective fire safety measures. In this approach, the fire hazard is defined as the product of the probability of fire ignition and the probable damage in the event of fire outbreak.

Most of the fire-hazard analysis models focus on the possible extent of damage and the concomitant economic loss, the size of the affected area or the duration of the fire. Therefore, the goal of this study is to elucidate the relation between the probability of the fire outbreak and the conditions within the industrial structure by employing the Structural Equation Modeling (SEM) technique.

### Fire ignition

For a fire outbreak to occur three basic preconditions are necessary: a source of ignition, fuel (flammable materials), and oxygen. The main

\* The corresponding author; E-mail: joze.srekl@fkkt.uni-lj.si  
Phone: + 386 1 5007604 Fax: + 386 1 5007610

source of oxygen is normally freely available in the surrounding atmosphere and no additional source is usually required. Even in closed industrial structures fresh air is supplied via the ventilation systems.

Thus, we can conclude that the main cause of fire ignition lies in the combination of ignition sources and flammable materials. Ramachandran<sup>8</sup> opines that the probability of a fire outbreak depends on the nature and number of ignition sources in the structure. His analysis of fire statistical data for the groups of structures with similar fire hazard demonstrates that the probability of a fire outbreak depends on an exponential function of the structure area.

In his study, Holborn<sup>9</sup> showed that flames are the main cause for almost half (44 %) of all fire outbreaks in London. The high frequency of fire outbreaks and the concomitant damage, injuries, and fatalities is intimately related to the presence of flames is the conclusion that applies to all kinds of structures. In industrial buildings and warehouses, the most commonly encountered sources of flames include various tools and industrial (especially welding and cutting) equipment. The next most common cause of fire outbreaks are electrical installations.

Lizhong<sup>10</sup> analyzed the fire statistics in China and concluded that faulty electrical installations are the leading cause of fire outbreaks, followed by open fires in everyday use, smoking, and disregard for fire safety precautions.

According to Hashofer and Thomas,<sup>6</sup> the availability of flammable materials (fuels), such as textiles, gasoline and other oil derivatives, gas, wood, flammable synthetic (polymer) materials etc., is another important cause of fire outbreaks. In industrial structures and warehouses, flammable materials are the main cause of fire outbreak and spreading.

## Fire statistics in the Republic of Slovenia

The number of fires has increased 60 % over the last 15 years. This number is excessively high for a small country with some two million inhabitants. Excluding the residential areas, statistics show a much smaller increase, which still exceeds 30 % during this period. It also worth noting that the total damage associated with industrial fires dwarfs the damage to the residential structures.

The most common cause of fire outbreak is the presence of open flames, followed by spontaneous ignition, and finally various smoking (tobacco) products. In approximately 30 % of the fires, the cause of the outbreak is unknown. When focusing

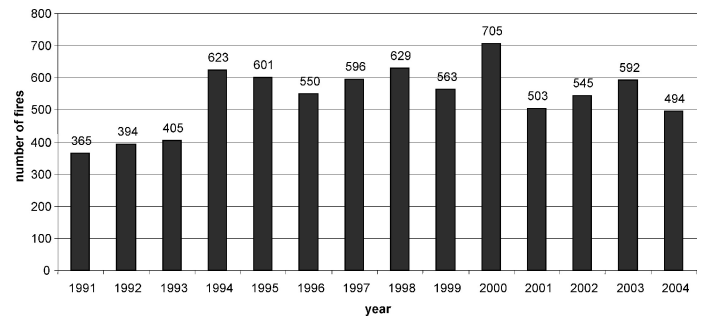

Fig. 1 – The number of fire outbreaks in non-residential structures in the RS during the 1991-2004 period<sup>1,2</sup>

on the fire outbreaks occurring in industrial structures, we must bear in mind that the activities there are normally conducted in accordance with strict professional rules and regulations. Failures and mistakes are rarely the cause of fire outbreak. In fact, there is no unambiguous answer in the fire statistics to the question as to why the fires in the industrial structures occur. Since a fire outbreak is a relatively rare event, it is difficult to find any correlation between the working process conducted in the industrial structure and the causes of ignition. Therefore, we have analyzed a random sample comprising 134 different industrial structures (metallurgy 25 %, chemical industry 20 %, wood industry 17 %, food industry 7 %, hotels and restaurants 13 % and warehouses 16 %) with the sole purpose of establishing whether there exists any connection between the activity conducted in the structure and the fire frequency. The areas of the analyzed industrial structures range between 40 m<sup>2</sup> and 125,000 m<sup>2</sup>, with 57 structures with areas smaller than 1,000 m<sup>2</sup>, 41 structures with areas between 1,000 m<sup>2</sup> and 10,000 m<sup>2</sup>, and 15 structures with areas greater than 10,000 m<sup>2</sup>.

## The area of structures and the frequency of fires

A review of statistical studies on this subject shows that the probability of fire ignition can be given as:<sup>8</sup>

$$P(A) = K A^\alpha \quad (1)$$

where  $A$  denotes the structure area, and  $K$  and  $\alpha$  are the constants for the specific group (risk category) of the structure. This conclusion was reached on the basis of the fire statistics in the UK, and does not include influence of the number of people, or their activities in the area under consideration. Brandyberry and Apostolakis,<sup>11</sup> however, claim that the frequency of fire outbreaks depends on the frequency of exposition to various sources of heat.

In the Slovenian case, the area of structures exerts only a very weak influence on fire frequency. By applying the statistical multivariate regression on our sample of structures, we tried to find a connection between the fire frequencies, the area of structures, the daily working hours, and the number of people employed in the structure. This resulted in the regression equation (computing with LISREL):

$$f_f = 0.0397 - 0.0251A + 0.609t + 0.00111n + \text{error}(2)$$

$f_f$  ... fire frequency,  $A$  ... structure area,  $t$  ... daily working hours, and  $n$  ... number of employees. All variables are standardized.

The fire frequency statistically significantly depends only upon the daily working hours (i.e. “exposition time”). By applying the SEM technique on our studied random sample, we obtained a statistically significant covariance between this parameter of the structure and the fire frequency (Table 1).

Table 1 – Covariance between fire frequency and structure parameters

	$A$	$t$	$n$
$f_f$	0.00	0.40	0.00

On the basis of these results, we can conclude that the fire hazard in industrial structures is not significantly related to the area of the structure, but rather to the working hours. The most acute risks are posed by early morning and late night work. The statistical data showed that the majority of fires broke out during these two critical periods. Longer working hours thus also include more “critical time”, hence the longer workday also poses greater risk of a fire outbreak.

## The SEM analyses

### Data acquisition

The main goal of this study was to construct a theoretical model relating the frequency of fire outbreaks to different parameters of the structure (surface area, share of flammable building materials), the working processes conducted in these structures (with particular emphasis on the available source of ignition in these processes), and the flammable materials utilized in them. The most pertinent question in our analysis is why the fire occurs. Our expectations are that the answer to this question lies in the combination of available quantities of flammable materials, and the presence of open flames or

sparks (sources of ignition). The technological processes are conducted in a work environment where many different factors influence fire safety. Therefore, the multiple regression method would ostensibly seem to be the most appropriate statistical analysis method. However, this method ignores the possible mutual dependence of different factors. Hence, we believe that the SEM offers a superior approach to fire statistics analysis. If we disregard the extent of damage incurred in the fire, we must focus our analysis on the causes of fire ignition. The statistical study of the sample attempts to find the correlations between the conditions in the structure, and the number of fires during a certain period (fire frequency). Thus, our studied random sample of 134 structures included the gathered data regarding the type of activities within the structure, number of employees, area and volume of structure, types of construction materials, types of materials utilized in the work processes (with special emphasis on dusts and flammable materials), transport of flammable materials within and between the structures, availability of heat sources (open flames, sparks, hot surfaces), electrical installations (age, maintenance, condition), the number of smokers in the workforce. This data is analyzed for any possible correlations with the fire statistics – i.e. the number of fire outbreaks within the last 5 and 10 years. Since many of these variables in our sample showed no correlation (i.e. the correlation coefficient was nearly zero) with the fire frequency – they were either independent or negatively dependent – they had to be eliminated from further analysis.

A characteristic of the studied random sample is that it contains structures in which the mean value of the fire frequency during the 5 year period exceeds 1 (*average1* = 1.0672 and *average2* = 1.2164). This average includes all known fire ignitions, regardless of whether they escalated to a sizable fire. About one third of the studied structures suffered at least one fire outbreak, and more than half of these had multiple fire outbreaks during this period (Fig. 2).

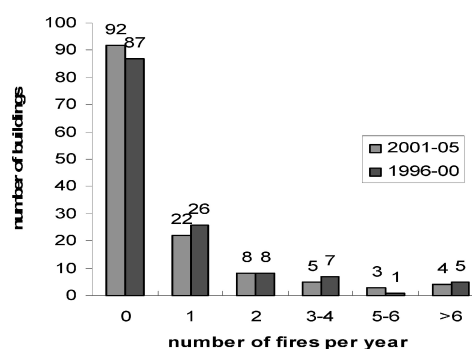

Fig. 2 – Number of structures related to the number of fire outbreaks over two 5-year periods

The sources of ignition are present in two thirds of the studied structures. Twenty percent of the structures have total exposition time (number of sources multiplied by the average monthly exposition time) higher than 1000 h, which in average translates to more than one permanent source of ignition (Fig. 3).

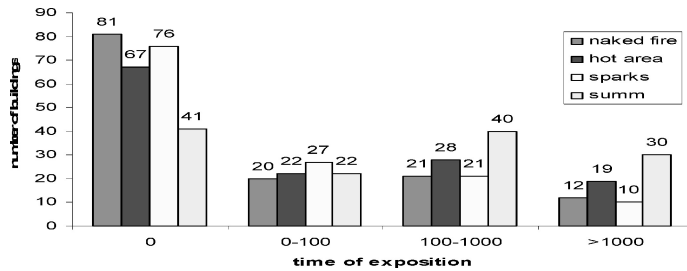

Fig. 3 – Number of structures with different times of exposition to fire ignition sources

No flammable materials are utilized in 41 % of structures. In the rest of our studied sample, the average value of flammable materials utilization is 157 t y<sup>-1</sup>, with the standard deviation of 1242 t.

### The model construction

The multiple regression method contains the dependencies between the endogenous variables, which measure the probability of ignition, and the exogenous factors of the work process. However, the regression does not take into account any possible interconnections between the exogenous factors. We expect that some interconnections exist between the working time, exposition to the sources of ignition, quantity of flammable materials, number of workers etc. Therefore, we have decided to apply the SEM approach with the LISREL (linear structural relationship) model to the fire statistics analyses, since this approach enables the analysis to encompass the internal interdependencies between the various factors. The LISREL model consists of two basic components:<sup>12</sup>

1. The structural model with a matrix equation:

$$\eta = \mathbf{B}\eta + \mathbf{\Gamma}\xi + \zeta \quad (3)$$

2. Two measurement models:

$$\mathbf{y} = \mathbf{\Lambda}_y\eta + \varepsilon \quad (4)$$

$$\mathbf{x} = \mathbf{\Lambda}_x\xi + \delta \quad (5)$$

In the above equations  $\eta$  and  $\xi$  denote the vectors of latent variables,  $\mathbf{x}$  and  $\mathbf{y}$  the vectors of observed variables,  $\varepsilon$  and  $\delta$  the vectors of measurement errors, and  $\zeta$  the vector of structural errors.  $\mathbf{y}$  and  $\eta$  denote the endogenous (dependent) variables, while  $\xi$ ,  $\mathbf{x}$ ,  $\varepsilon$ ,  $\delta$ , and  $\zeta$  are the exogenous (independ-

ent) variables.  $\mathbf{\Lambda}_y$  and  $\mathbf{\Lambda}_x$  are the matrices of the factor weights between  $\mathbf{y}$  and  $\eta$ , and between  $\mathbf{x}$  and  $\xi$ , respectively. From the eq. (3) we obtained:

$$\eta = (\mathbf{I} - \mathbf{B})^{-1} \mathbf{\Gamma} \xi + (\mathbf{I} - \mathbf{B})^{-1} \zeta \quad (6)$$

Where  $\mathbf{B}$  (beta, BE) is the matrix of the regression coefficients for  $\eta$ , and  $\mathbf{\Gamma}$  (gamma, GA) is the matrix of the regression coefficients between  $\eta$  and  $\xi$ . It can be assumed that the mean value of  $\zeta$  is 0, with no loss of generality.

### The first SEM model

The first step in the construction of SEM model is the selection of several characteristic variables. As emphasized previously, the preconditions for the ignition of a fire are the exposition to various sources of ignition, and fuel (flammable materials), since the source of oxygen is normally already provided by air. In this analysis we have neglected the flammable construction materials, thus focusing on the materials utilized in the work processes. The next step is to select the measurement model for the exogenous variables  $\mathbf{x}$  and the latent variables  $\xi$  (Table 2).

Table 2 – Exogenous ( $\mathbf{x}$ ) and latent ( $\xi$ ) variables

Exogenous variables, $\mathbf{x}$	Latent variables, $\xi$
LFMAT = logarithm of the total monthly mass of flammable materials	material
CLEAN_M = flammable cleaning materials (variable range: frequent use-2, rare-1, never-0). How frequent is the use of flammable cleaning materials in industrial structures.	
TRANSP = (nominal variable) If transport of flammable materials within the structure exists, we have a value-1, otherwise the value is 0.	
LNF = logarithm of the product of the number of open flame sources and the time of exposition	initial
LHA = logarithm of the product of the number of hot surface sources and the time of exposition	
LSPA = logarithm of the product of the number of sparks sources and the time of exposition	

The measurement construct for the exogenous variables – the ignition sources and fuel – is schematically presented in Fig. 4.

All values in the matrix of the regression coefficients (see Table 3), obtained with the LISREL program package (LISREL 8.1, Scientific Software International), are statistically significant, as shown in Table 3 ( $t$ -values are greater than critical value).

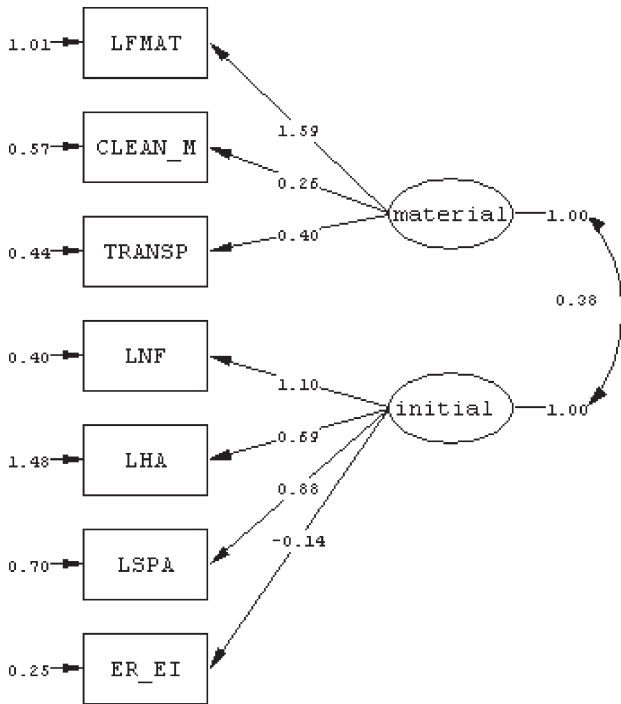

Fig. 4 – Measurement construct for the sources of ignition and fuel

Table 3 – Matrix of the regression coefficients (Values in table: estimates (standardized solution) t-value)

$\Lambda_x$	$\xi$	
	<i>material</i>	<i>initial</i>
LFMAT	1.59 (0.85)	5.92
CLEAN_M	0.26 (0.32)	3.16
TRANSP	0.40 (0.51)	4.57
LNF		1.10 (0.87) 9.75
LHA		0.69 (0.49) 5.47
LSPA		0.88 (0.72) 8.16
ER_EI		-0.14 (-0.28) -2.95

However, the structural model also shows (see Fig. 5) that there is no statistically significant correlation between the fuel quantity and the fire frequency (*t*-value is smaller than critical value).

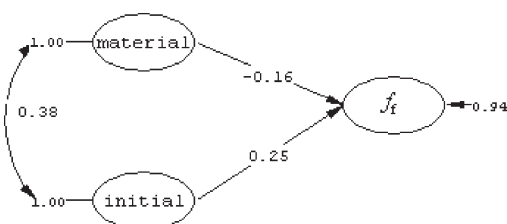

Fig. 5 – LISREL path diagram for the first SEM model

From this model we derived eq. (7), which relates the first latent variable *initial* to the endogenous variable that measures the fire frequency ( $f_f$ ). The variation of this endogenous variable is 0.94, which means that the explained variance is barely 6 % !

$$f_f = 0.25 \cdot initial - 0.16 \cdot material + 0.94 \quad (7)$$

The model thus indicates that the available fuel quantity has no statistically significant influence on the fire frequency. The latent variable *initial* that represents the influence of all sources of ignition, on the other hand, clearly exerts a statistically significant influence on the fire frequency.

However, the results of the model fit are quite poor, as may be seen from the LISREL program calculation (Table 4): with the well fitted models the GFI and AGFI indices both had values higher than 0.95, which led us to reject this model.

Table 4 – First SEM model fit indices calculated by the LISREL program package

Degrees of Freedom	24
Minimum Fit Function Chi-Square	48.78 ( $P = 0.0020$ )
Goodness of Fit Index (GFI)	0.92
Adjusted Goodness of Fit Index (AGFI)	0.85
Root Mean Square Residual (RMR)	0.15

### The second SEM model

The second SEM model was constructed in order to analyze the correlations between the fire frequency and the three exogenous indicators. As noted, the ignition sources, the work hours, and flammable materials are most intimately related to the frequency of fire outbreaks, or at least to the probability of fire ignition. To elucidate the correlation of the available fuel quantity with these indicators, we constructed a model comprising three independent indicators. All sources of ignition were incorporated into a single variable (*hot*), defined as:

$$\log\_hot = \log(1 + \bar{n}_1 \bar{t}_1 + \bar{n}_2 \bar{t}_2 + \bar{n}_3 \bar{t}_3) \quad (8)$$

In eq. (8)  $\bar{n}_i$  is the average number and  $\bar{t}_i$  the average time of exposition for the sources of open flames (1), hot surfaces (2), and sparks (3). The construct of interdependencies is shown in Fig. 6.

In Fig. 6, time (*t*) denotes the work hours (8, 12, 16, or 24 h), *material* is the logarithm of the available fuel quantity (in kg). The selected dependent latent variable  $f_f$  is the expected fire frequency, and the two independent indicators are the number of fire outbreaks during the two five-year

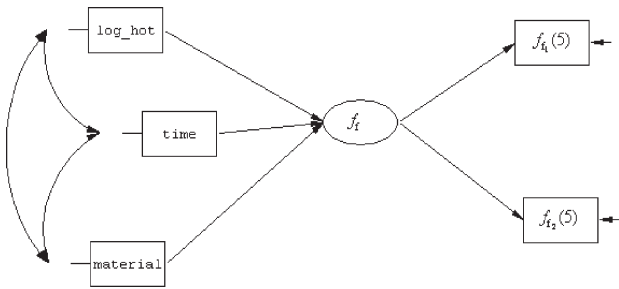

Fig. 6 – Construct of interdependencies for the second SEM analysis model

periods: 1996–2000 ( $f_{f_1}(5)$ ) and 2001–2005 ( $f_{f_2}(5)$ ). In the equation we used the standardized values without units.

We derived the SEM model equation (see Fig. 7) as follows:

$$f_f = 0.16 \cdot \log\_hot + 0.46 \cdot t - 0.16 \cdot \log m + 0.74 \quad (9)$$

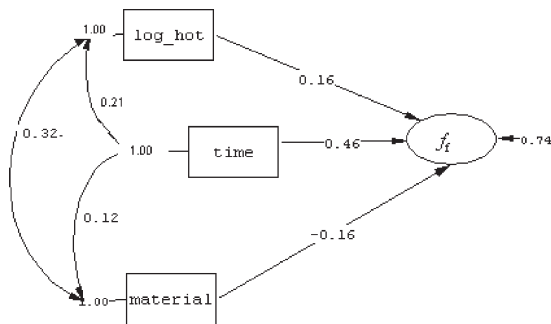

Fig. 7 – LISREL path diagram for the second SEM model

The results of the model fit calculations for this SEM model show a very good fit, with the NFI index higher than 0.95, and the GFI index equal 1. As may be seen, the available quantity of flammable materials (fuel) has no statistically significant influence on the fire frequency ( $t$ -value is lower than 2). The reasons for this somewhat unexpected result may be found in the very strict legislation regarding flammable materials in the RS. Furthermore, the observation period is rather short, and the sample is small, so it will be necessary to collect data for a longer period to verify this conclusion reliably.

*The reduced SEM model*

Since both SEM models, regardless of their fit results, indicate strongly that the available fuel quantity exerts no statistically significant influence on the fire frequency in the researched random sample, the last step in our SEM analysis entails the reduction of the second SEM model to only two independent indicators: the logarithm of the work hours, and the time of exposition to the ignition sources. The logarithm of time is used because the

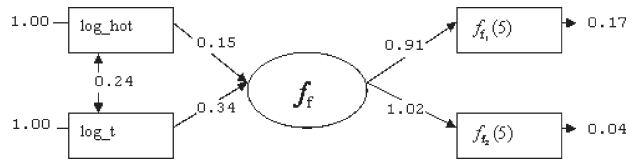

Fig. 8 – LISREL path diagram for the reduced SEM model

Table 5 – Reduced SEM model fit indices calculated by the LISREL program package

Degrees of Freedom	1
Minimum Fit Function Chi-Square	0.027 ( $P = 0.87$ )
Goodness of Fit Index (GFI)	1.00
Adjusted Goodness of Fit Index (AGFI)	1.00
Root Mean Square Residual (RMR)	0.0081

fitting of model is much better. The LISREL path diagram for this reduced model is shown in Fig. 8.

The equation of the reduced SEM model is:

$$f_f = 0.15 \cdot \log\_hot + 0.34 \cdot \log\_t + 0.84 \quad (10)$$

As may be seen from Table 5, the results of the reduced SEM model fit are much better than in the case of the first SEM model, and the explained variance is 16 %. These results led us to accept the reduced SEM model.

The measurement equation gives the relation between the fire frequency and the number of fire outbreaks in a five-year period.

$$f_{f_2}(5) = 1.02 \cdot f_f \quad (11)$$

With the aid of eqs. (10) and (11) we can calculate the boundary functions of the fire frequency, which correlate the work hours to the time of exposition to the sources of ignition in the work process. Fig. 9 shows the boundary functions for probable 2, 3, and 4 fire outbreaks during a five-year period.

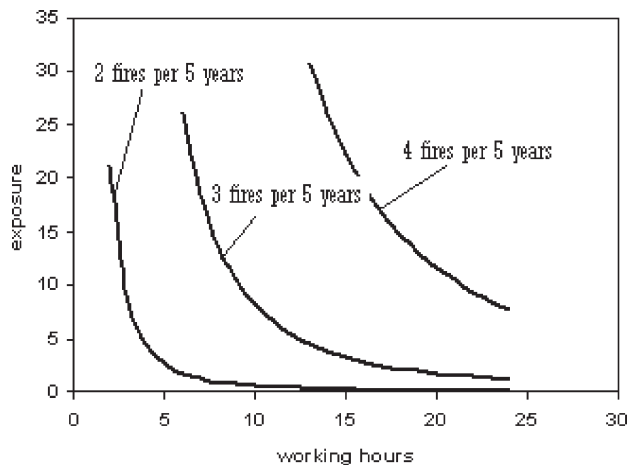

Fig. 9 – Boundary functions for probable 2, 3, and 4 fire outbreaks during a five-year period

## Conclusions

The SEM analysis is a statistical method that is not applied often in the fields of safety and fire safety sciences. The application of the SEM method presented in this study demonstrates that it is useful in the search for conclusions based on sample data. The result of this method in general does not evaluate a specific situation numerically, but rather helps explain the correlations between the observed indicators and the consequential values of variables.

Our analyses of the fire statistics of a random sample of 134 industrial structures in the RS show that there exists a significant correlation between the number of fire outbreaks and the exposition to the sources of ignition. The mean number of fires in the studied sample is 1.2, which means that each structure on average suffers at least one fire outbreak in five years. The probability of more fire outbreaks increases rapidly with increasing time of exposition to ignition sources. Our model also indicates that longer working hours statistically significantly influence the probability of fire outbreaks, especially during the critical periods of the day, i.e. in the early morning, late evening, and at night. These conclusions are well supported by the fire statistics of the RS for the 1991–2004 period,<sup>1,2</sup> which show that most of the fire outbreaks occur during these critical periods. Eq. 10 shows that there exists a statistically significant relationship between the frequency of fires and longer working hours, which includes the critical time of day. The fire statistics further show that the majority of fires break out due to the exposition to various ignition sources (open flames, sparks, and hot surfaces). The boundary functions give the necessary length of average monthly exposition to ignition sources in order to expect a specific number (in this study 2, 3, and 4) of fire outbreaks in the structure within a five-year period. Thus they can help to identify the hazardous work processes, and hence the need for stricter fire safety measures.

## List of symbols and abbreviations

$A$	– structure area
$B$	– regression coefficient matrix
$f_f$	– fire frequency

$K$	– constant in eq. (1)
$n$	– number of employees
$\bar{n}_i$	– average number
$P$	– probability
$t$	– time, h
$\bar{t}$	– average time, h
$t$	– test
$x$	– observed exogenous vector
$y$	– observed endogenous vector
$\alpha$	– exponential constant
$\Gamma$	– regression coefficient matrix
$\delta$	– measurement error vector
$\varepsilon$	– measurement error vector
$\zeta$	– structural error vector
$\eta$	– latent endogenous vector
$\xi$	– latent exogenous vector
$\Lambda$	– factor weight matrix
SEM	– structural equation modeling
LISREL	– linear structural relationship

## References

1. *Cvetko, A.*, Statistična obdelava požarov na gradbenih objektih v R Sloveniji od 1991 do 2000 leta. Diplomsko delo (mentor Šrekl J.), FKKT, Ljubljana, 2002.
2. Naravne in druge nesreče v RS – Letni bilten. 2001, 2002, 2003, 2004, 2005, URSZR, <http://www.sos112.si/slo/page.php?src=li18.htm>
3. *Seo, D.*, *Safety Science* **43** (2005) 187.
4. *Petersen, D.*, *Safety Management, a Human Approach*, Aloray, Inc., Goshen, New York, 1988.
5. *Heinrich, H. W., Petersen, D., Roos, N.*, *Industrial Accident Prevention*, McGraw-Hill, Inc., New York, 1980.
6. *Hashofer, A. M., Thomas, I.*, *Fire Safety Journal* **41** (2006) 2.
7. *Telesca, L., Lasaponara, R.*, *Physica A* (2006) 543.
8. *Ramachandran, G.*, *Fire Technology* **24** (3) (1988) 204.
9. *Holborn, P. G., Nolan, P. F., Golt, J. Townsend, N.*, *Fire Safety Journal* **37** (2002) 303.
10. *Lizhong, Y., Xiaodong, Z., Zhihua, D., Weicheng, F., Quing'an, W.*, *Fire Safety Journal* **37** (2002) 785.
11. *Brandyberry, M. D., Apostolakis, G. E.*, *Fire Safety Journal* **17**(1991) 339.
12. *Hershberger, S. L., Marcoulides, G. A., Parramore, M. M.*, *Structural equation modeling: an introduction*. in *Purgesek B. H. et al. (EDS), Structural Equation modeling*, 1st edn, Cambridge UP, Cambridge (2002), pp 3-41.